



CANAL COMPACT CANAL PLUS

Energy
SAVERS
LOW-H₂O

Montagehandleiding / Instructions de montage
Montagehinweis / Mounting instructions

Standaard levering
Livraison standard
Standard Lieferung
Standard delivery

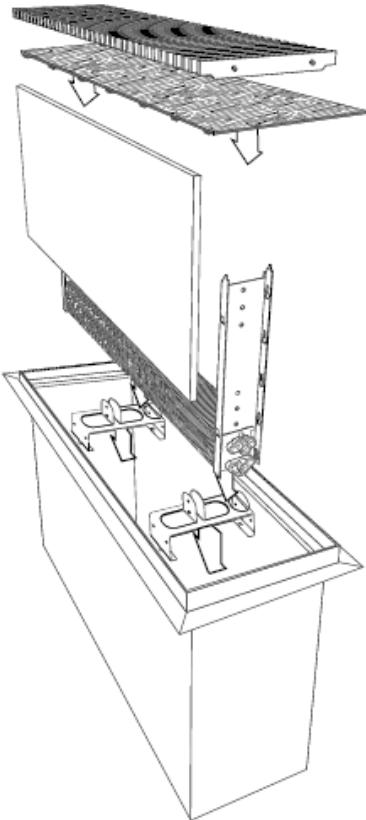

- > Standaard aansluitbaar links of rechts.
- > Raccordement standard à gauche ou à droite.
- > Standarda β links oder rechts.
- > Standard connection left or right.

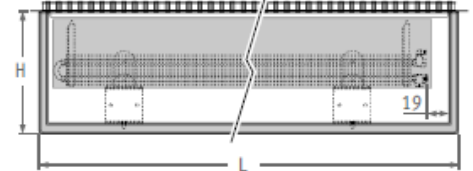
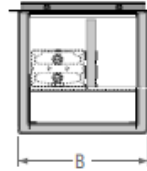

OPTIE_OPTION

Flexibele aansluiting
Raccordement avec flexibles
Flexible Schlauchanschlüsse
Flexible connections

Code: CCFC.000060

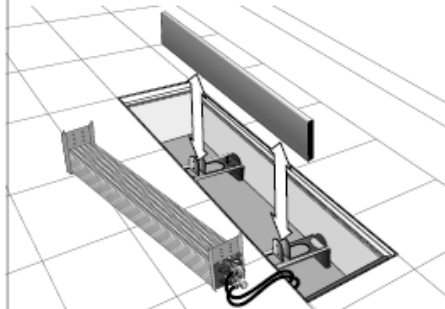
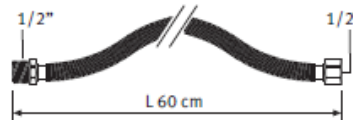

Werkingsprincipe
Principe de fonctionnement
Wirkungsprinzip
Operating principal

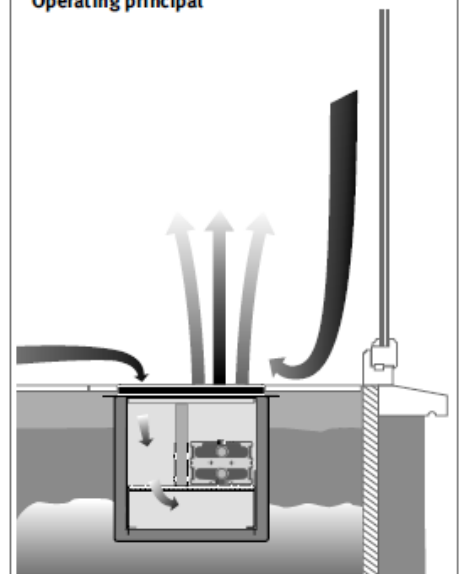

Waarschuwing
Avertissement
Warnung
Warning

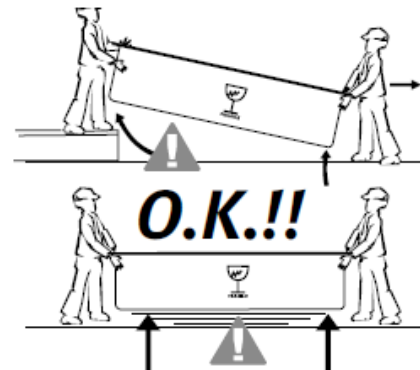
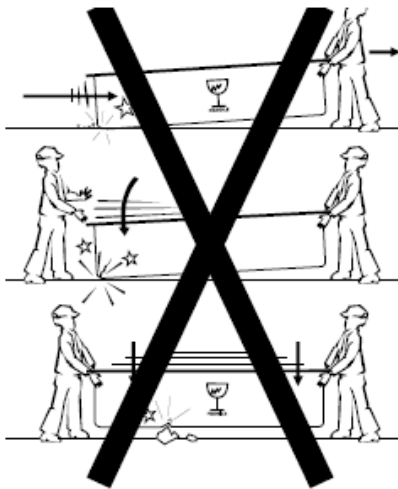

= GEEN GARANTIE
= PERTE DE GARANTIE
= KEINE GARANTIE
= NO GUARANTEE

OPGELET !! Garantie waterdichtheid: vermijdt felle schokken of het slepen van de put over de grond.

ATTENTION !! Garantie étanchéité: éviter des chocs trop violents ou de trainer le caniveau sur le sol.

ACHTUNG !! Garantie wasserdichtheid: Stöße oder am Boden schleppen soll vermieden werden.

ATTENTION !! Waterproof guarantee: avoid violent chocs or dragging on the floor.

OPTIE AANSLUITSET _ OPTION KIT DE RACCORDEMENT _ OPTION ANSCHLUßSATZ _ OPTION CONNECTION SET

SET 73 _ KV 0.6 _ TWEEPIJP / BITUBE / ZWEIROHR / TWO PIPE

CODE	
COCPJF2.MA.2...	
COCPJF2.DW.2...	
COCPJF2.JB.2...	
COCPJF2.RM.2...	
COCPJF2.DS.2...	

klemkoppeling / raccord bicône
Klemmringverschraubung / sleeve coupling

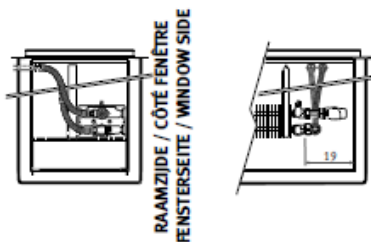

VOORBEELD: Thermostaatkop met voeler op afstand
EXEMPLE: Tête de vanne thermostatique avec capteur à distance
BEISPIEL: Thermostatkopf mit Fernfühler
EXAMPLE: TRV head with sensor at distance

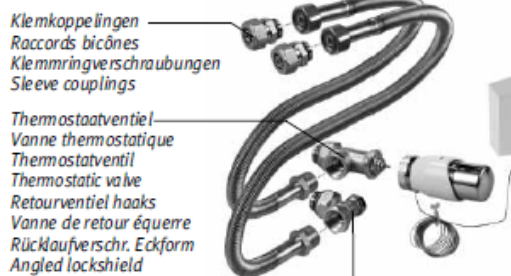

SET 74 _ KV 0.6 _ TWEEPIJP / BITUBE / ZWEIROHR / TWO PIPE

CODE	
COCP.E60.MA.2...	
COCP.E60.JB.2...	
COCP.E30.MA.2...	
COCP.E30.JB.2...	
COCP.E60.RM.2...	
COCP.E30.RM.2...	

klemkoppeling / raccord bicône
Klemmringverschraubung / sleeve coupling

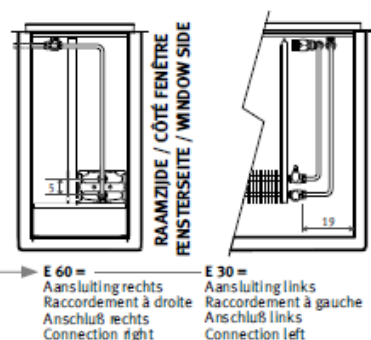

VOORBEELD: Thermostaatkop met aansluitverlenging
EXEMPLE: Tête de vanne thermostatique avec raccordement rallongé
BEISPIEL: Thermostatkopf mit Anschlußverlängerung
EXAMPLE: TRV head with extended connection

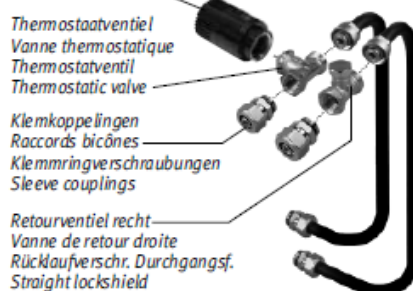

SET 72 _ KV 0.6 _ TWEEPIJP / BITUBE / ZWEIROHR / TWO PIPE

CODE	
COMCJV2.MA.2...	
COMCJV2.DW.2...	
COMCJV2.JB.2...	
COMCJV2.RM.2...	
COMCJV2.DS.2...	

klemkoppeling / raccord bicône
Klemmringverschraubung / sleeve coupling

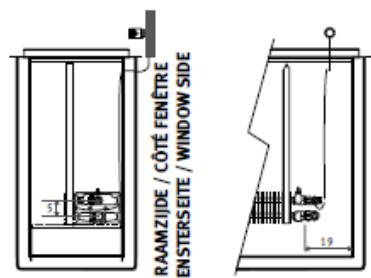

VOORBEELD: Thermostaatkop met voeler op afstand
EXEMPLE: Tête de vanne thermostatique avec capteur à distance
BEISPIEL: Thermostatkopf mit Fernfühler
EXAMPLE: TRV head with sensor at distance

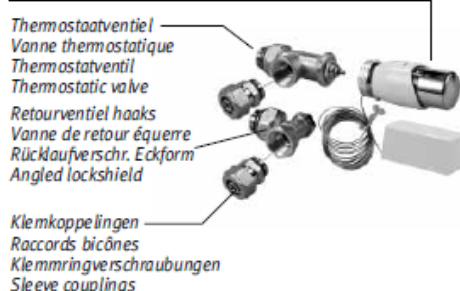

KLEMKOPPELINGEN _ RACCORDS BICÔNES _ KLEMMRINGVERSCHRAUBUNGEN _ SLEEVE COUPLINGS

FLEXIBEL STAAL OF KOPERBUIS
TUYAU FLEXIBLE EN ACIER OU EN CUIVRE
FLEXIBLES STAHL- ODER KUPFERROHR
FLEXIBLE STEEL OR COPPER TUBE

KUNSTSTOF BUIS
TUYAU SYNTHÉTIQUE
KUNSTSTOFF ROHR
SYNTHETIC TUBE

VPE/ALU BUIS
TUYAU EN PER/ALU
VPE/ALU ROHR
RPE/ALU TUBE

STALEN C.V. BUIS
TUYAU EN ACIER
EISENROHR
STEEL TUBE

CODE	Ø	
110	10/1	
112	12/1	
114	14/1	
115	15/1	
116	16/1	
118	18/1	

CODE	Ø	
212	12/2	
213	12/1	
214	14/2	
219	16/1.5	
216	16/2	
217	17/2	
218	18/2	

CODE	Ø	
314	14/2	
316	16/2	
326	16/2.2	
318	18/2	
336	16/2.2	
Alleen voor TECE buis (Nederland)		

CODE	Ø	
502	1/2"	
504	3/8"	
Meerprijs Supplément de prix Mehrpreis Surcharge		

- N** BESTELCODE AANSLUITSET AANVULLEN MET CODE KLEMKOPPELING VOLGENS GEBRUIKTE BUIS EN Ø.
De juiste uitvoering klemkoppelingen wordt bepaald door de code van de aansluitset (Inbegrepen in de prijs van de aansluitsets).
- F** CODE DU KIT DE RACCORDEMENT À COMPLÉTER AVEC CODE DE COMMANDE DU RACCORD BICÔNE, DÉPENDANT DE LA MATIÈRE ET Ø DU TUYAU.
Le type correct du raccord bicône sera déterminé par le code du kit complet (Compris dans le prix des kits de raccordement).
- D** AN DIE ARTIKELNUMMER DES ANSCHLUSSSATZES DEN KODE DER KLEMMRINGVERSCHRAUBUNG ANHÄNGEN, ENTSPRECHEND DEM ROHR UND DEM Ø.
Der richtige Typ der Klemmringverschraubung wird durch den Kode im Anhang an die Artikelnummer bestimmt (Im preis der Anschlußsätze enthalten).
- E** COMPLETE ORDERING CODE CONNECTION SET WITH CODE SLEEVE COUPLINGS ACCORDING TO THE USED MATERIAL AND Ø OF THE TUBE.
The right type of sleeve coupling is determined by the ordering code of the connection set (Included in the price of the connection sets).

