

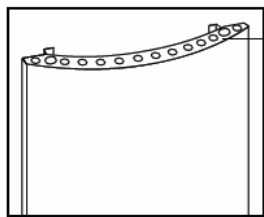

JAGA GEO függőleges kivitel méretek

Adatok cm-ben



Függőleges konvekciós cső
(a H180 L60 típusnál)

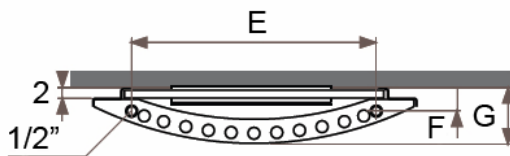

Csatlakozási
lehetőségek

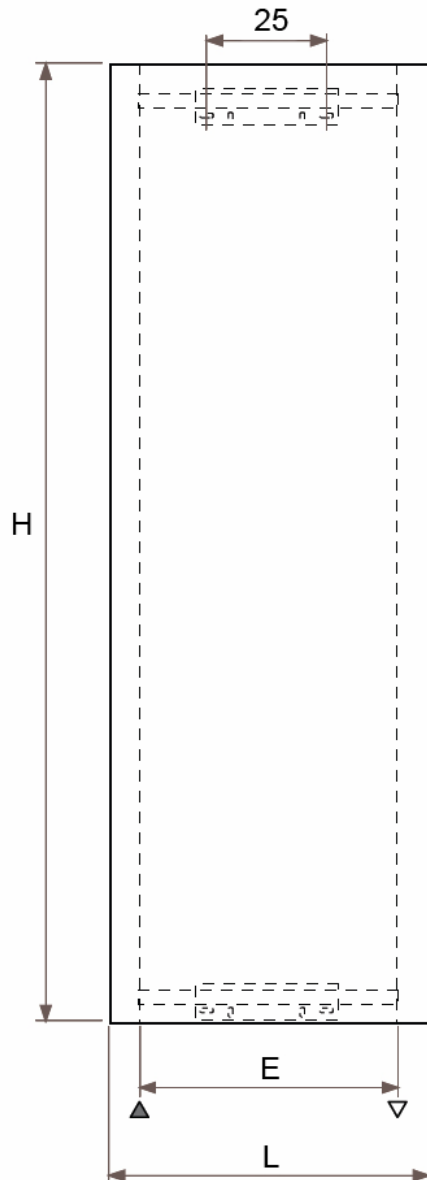
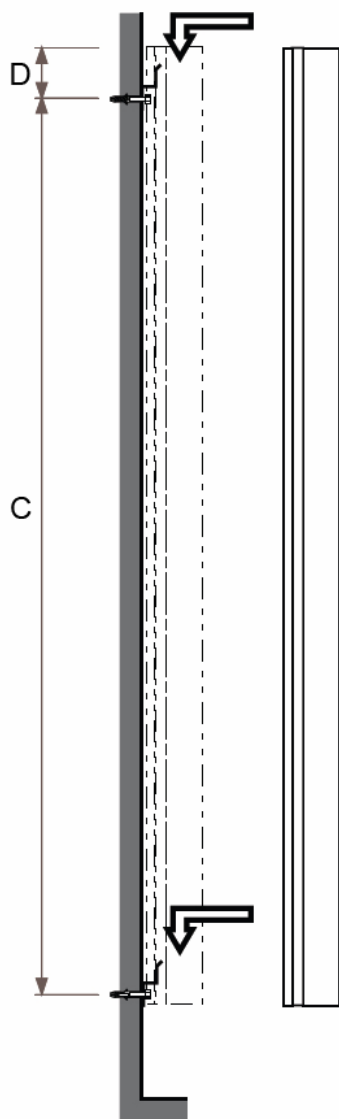
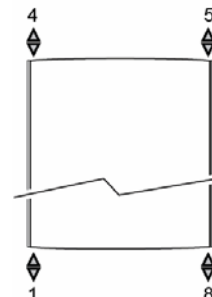

A törölközőtartók
lehetséges
elhelyezései

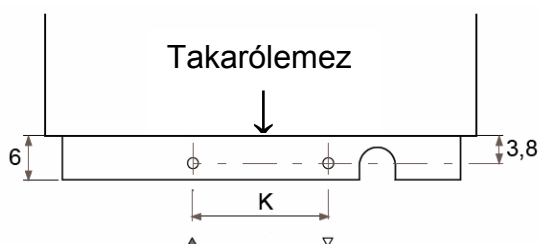
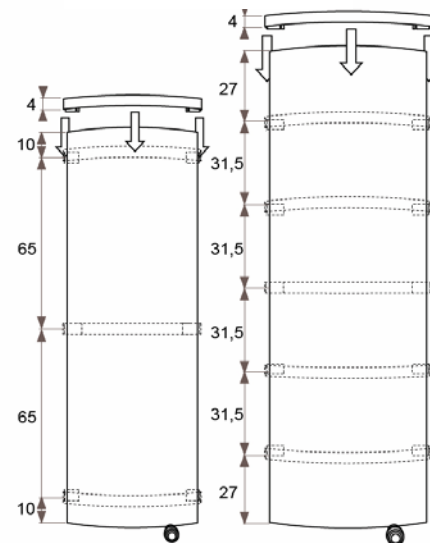

H	150	180
L	50,0	60,0
C	106,0	170,0
D	25,5	8,5
E	40,0	46,0
F	4,0	4,5
G	8,4	10,5
K	17,0	23,0



JAGA GEO függőleges kivitelhez csőkiállítás

Adatok cm-ben

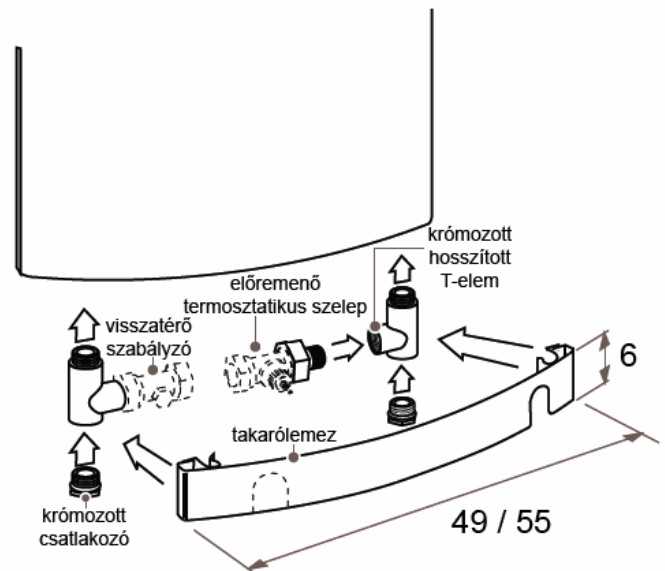
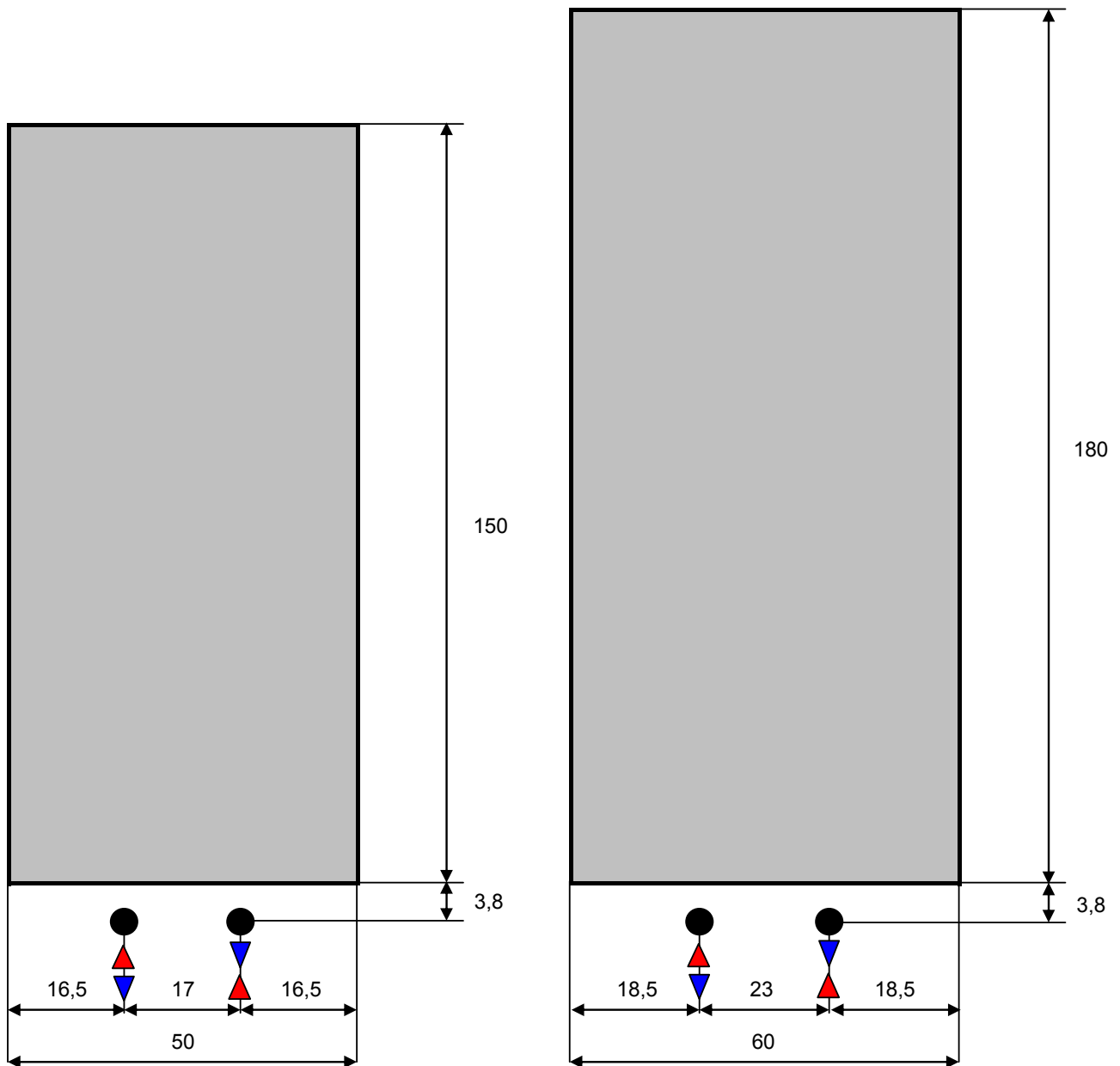

Falból jövő csövek esetén a GEO kőradiátorhoz tartozó komplett szelepkészlet:

Van lehetőség elektromos fűtőpatron bekötésére is (T-elembe).